

भारतीय मानक
Indian Standard

IS 383 : 2016

कंक्रीट के लिए मोटे व महीन
मिलावा — विशिष्टि

(तीसरा पुनरीक्षण)

Coarse and Fine Aggregate for
Concrete — Specification

(Third Revision)



ICS 91.100.30

© BIS 2016



भारतीय मानक ब्यूरो
BUREAU OF INDIAN STANDARDS
मानक भवन, 9 बहादुरशाह ज़फर मार्ग, नई दिल्ली-110002
MANAK BHAVAN, 9 BAHADUR SHAH ZAFAR MARG
NEW DELHI-110002
www.bis.org.in www.standardsbis.in

January 2016

Price Group 8

FOREWORD

This Indian Standard (Third Revision) was adopted by the Bureau of Indian Standards, after the draft finalized by the Cement and Concrete Sectional Committee had been approved by the Civil Engineering Division Council.

Aggregates are important components for making concrete and properties of concrete are substantially affected by various characteristics of the aggregates used. Aggregates from natural sources form the major variety used for making concrete, mortar and other applications. This Indian Standard has been formulated to cover requirements for aggregates derived from natural sources and other than natural sources, for use in production of concrete.

Whilst the requirements specified in this standard generally meet the normal requirements for most of the concrete works, there might be special cases where certain requirements other than those specified in the standard might have to be specified; in such case, such special requirements, the tests required and the limits for such tests may be specified by the purchaser.

This standard was first published in 1952 and subsequently revised in 1963 and 1970. This revision has been taken up to incorporate the modifications found necessary in the light of experience gained in its use and also to bring it in line with the latest development on the subject. Significant modifications in this revision include,

- a) scope of the standard has been widened to cover aggregates from other than natural sources;
- b) definitions of various terms have been rationalized;
- c) limits for mica as deleterious material for muscovite and muscovite plus biotite varieties have been included;
- d) the requirements for crushing value, impact value and abrasion value have been classified under a common head of mechanical properties;
- e) requirement for flakiness and elongation has been specified for which a combined index has been introduced along with the procedure for determination of the same;
- f) provisions on alkali aggregate reactivity have been included to bring coherence of the same with IS 456 : 2000 'Code of practice for plain and reinforced concrete (*fourth revision*)' and requirements for compliance for the same have been included; and
- g) mixed sand has been included along with crushed sand.

Of late, scarcity in availability of aggregates from natural sources is being faced in some parts of the country. This may require supplementing the use of aggregates from natural sources with the use of aggregates from other sources. This revision therefore also covers provisions regarding quality requirements and those relating to the extent of utilization of iron slag, steel slag, copper slag, bottom ash from thermal power plants recycled concrete aggregates (RCA) and recycled aggregate (RA), along with necessary provisions relating to their utilization. RCA and RA may in turn be sourced from construction and demolition wastes. A brief note on manufacture of various types of such manufactured aggregates is given at Annex A. A crusher dust (or quarry dust) produced from the fine screening of quarry crushing cannot be called crushed sand as per 3.1.2. It may not be generally in conformity to the requirement of crushed sand as per the standard and is not expected to perform as efficiently as properly crushed sand, unless it is processed to meet the requirement of this standard.

This standard contains clauses such as 8.1, 8.2, 8.3, 8.4, 9.1 and 9.2 which call for agreement between the purchaser and the supplier and require the supplier to furnish technical information as given in Annex B.

The composition of the Committee responsible for the formulation of this standard is given in Annex F.

For the purpose of deciding whether a particular requirement of this standard is complied with, the final value, observed or calculated, expressing the result of a test or analysis shall be rounded off in accordance with IS 2 : 1960 'Rules for rounding off numerical values (*revised*)'. The number of significant places retained in the rounded off value should be the same as that specified value in this standard.

Indian Standard

**COARSE AND FINE AGGREGATE FOR
CONCRETE — SPECIFICATION**

(Third Revision)

1 SCOPE

This standard covers the requirements for aggregates, crushed or uncrushed, derived from natural sources, such as river terraces and riverbeds, glacial deposits, rocks, boulders and gravels, and manufactured aggregates produced from other than natural sources, for use in the production of concrete for normal structural purposes including mass concrete works.

2 REFERENCES

The standards listed below contain provisions which, through reference in this text, constitute provisions of this standard. At the time of publication, the editions indicated were valid. All standards are subject to revision, and parties to agreements based on this standard are encouraged to investigate the possibility of applying the most recent editions of the standards indicated below:

<i>IS No.</i>	<i>Title</i>
2386	Methods of test for aggregates for concrete:
(Part 1) : 1963	Particle size and shape
(Part 2) : 1963	Estimation of deleterious materials and organic impurities
(Part 3) : 1963	Specific gravity, density, voids, absorption and bulking
(Part 4) : 1963	Mechanical properties
(Part 5) : 1963	Soundness
(Part 6) : 1963	Measuring mortar making properties of fine aggregate
(Part 7) : 1963	Alkali aggregate reactivity
(Part 8) : 1963	Petrographic examination
2430 : 1986	Methods for sampling of aggregates for concrete (<i>first revision</i>)
4032 : 1985	Method of chemical analysis of hydraulic cement (<i>first revision</i>)
4905 : 1968	Methods for random sampling
6461 (Part 1) : 1972	Glossary of terms relating to cement concrete: Part 1 Concrete aggregates
9198 : 1979	Specification for compaction rammer for soil testing
9669 : 1980	Specification for CBR moulds and its accessories
14959 (Part 2) : 2001	Method of Test determination of water soluble and acid soluble chlorides in mortar and concrete: Part 2 Hardened mortar and concrete

3 TERMINOLOGY

For the purpose of this standard, the definitions given in IS 6461 (Part 1) and the following shall apply.

3.1 Fine Aggregate — Aggregate most of which passes 4.75 mm IS Sieve and contains only so much coarser material as permitted in 6.3.

3.1.1 Natural Sand — Fine aggregate resulting from the natural disintegration of rock and which has been deposited by streams or glacial agencies. This may also be called as uncrushed sand.

3.1.2 Crushed Sand

3.1.2.1 Crushed stone sand — Fine aggregate produced by crushing hard stone.

3.1.2.2 Crushed gravel sand — Fine aggregate produced by crushing natural gravel.

3.1.3 Mixed Sand — Fine aggregate produced by blending natural sand and crushed stone sand or crushed gravel sand in suitable proportions.

3.1.4 Manufactured Fine Aggregate (Manufactured Sand) — Fine aggregate manufactured from other than natural sources, by processing materials, using thermal or other processes such as separation, washing, crushing and scrubbing.

NOTE — Manufactured fine aggregate may be Recycled Concrete Aggregate (RCA) (*see Annex A*).

3.2 Coarse Aggregate — Aggregate most of which is retained on 4.75 mm IS Sieve and containing only so much finer material as is permitted for the various types described in this standard.

NOTE — Coarse aggregate may be,

- a) uncrushed gravel or stone which results from natural disintegration of rock;
- b) crushed gravel or stone when it results from crushing of gravel or hard stone; and
- c) partially crushed gravel or stone when it is a product of the blending of (a) and (b);
- d) manufactured from other than natural sources, by processing materials, using thermal or other processes such as separation, washing, crushing and scrubbing. Manufactured coarse aggregate may be Recycled Concrete Aggregate (RCA) or Recycled Aggregate (RA) (*see Annex A*).

3.3 All-in-Aggregate — Material composed of fine aggregate and coarse aggregate.

4 CLASSIFICATION

The aggregate shall be classified as given in 4.1 and 4.2. In case of mixed sand (see 3.1.3), the manufacturer/supplier should supply the individual sands to be mixed at site, at the time of batching.

4.1 Aggregates from Natural Sources

These shall be coarse and fine aggregates as defined in 3.1.1, 3.1.2, 3.1.3 and 3.2 [see also Note under 3.2(a), (b) and (c)]

4.2 Manufactured Aggregates and Extent of Utilization

4.2.1 These shall be coarse and fine aggregates as defined in 3.1.4 and 3.2 [see also Note under 3.2(d)].

The manufactured aggregates shall be permitted with their extent of utilization as percent of total mass of fine or coarse aggregate as the case may be, as indicated in Table 1 against each, for use in plain and reinforced concrete and lean concrete.

4.2.2 Manufactured aggregates shall not be permitted for use in prestressed concrete.

5 QUALITY OF AGGREGATE

5.1 General

Aggregate shall be naturally occurring (crushed or uncrushed) stones, gravel and sand or combination thereof or produced from other than natural sources. They shall be hard, strong, dense, durable, clear and free from veins; and free from injurious amounts of disintegrated pieces, alkali, free lime, vegetable matter and other deleterious substances as well as adherent coating. As far as possible, scoriaceous, flaky and elongated pieces should be avoided.

5.2 Deleterious Materials

Aggregate shall not contain any harmful material, such as pyrites, coal, lignite, mica, shale or similar laminated material, clay, alkali, free lime, soft fragments, sea shells and organic impurities in such quantity as to affect the strength or durability of concrete. Aggregate to be used for reinforced concrete shall not contain any material liable to attack the steel reinforcement.

5.2.1 Limits of Deleterious Materials

The maximum quantity of deleterious materials shall not exceed the limits specified in Table 2. However, the engineer-in-charge at his discretion, may relax some of the limits as a result of some further tests and evidence of satisfactory performance of the aggregates.

Table 1 Extent of Utilization
(Clause 4.2.1)

Sl No.	Type of Aggregate	Maximum Utilization		
		Plain Concrete Percent	Reinforced Concrete Percent	Lean Concrete (Less than M15 Grade) Percent
(1)	(2)	(3)	(4)	(5)
i) Coarse aggregate:				
	a) Iron slag aggregate	50	25	100
	b) Steel slag aggregate	25	Nil	100
	c) Recycled concrete aggregate ¹⁾ (RCA) (See Note 1)	25	20 (Only upto M25 Grade)	100
	d) Recycled aggregate ¹⁾ (RA)	Nil	Nil	100
	e) Bottom ash from Thermal Power Plants	Nil	Nil	25
ii) Fine aggregate:				
	a) Iron slag aggregate	50	25	100
	b) Steel slag aggregate	25	Nil	100
	c) Copper slag aggregate	40	35	50
	d) Recycled concrete aggregate ¹⁾ (RCA) (See Note 1)	25	20 (Only upto M25 Grade)	100

¹⁾ See A-3 for brief information on recycled aggregates (RA) and recycled concrete aggregates (RCA).

NOTES

1 It is desirable to source the recycled concrete aggregates from sites being redeveloped for use in the same site.

2 In any given structure, only one type of manufactured coarse aggregate and one type of manufactured fine aggregate shall be used.

3 The increase in density of concrete due to use of copper slag and steel slag aggregates need to be taken into consideration in the design of structures.

4 While using manufactured aggregate as part replacement for natural aggregate, it should be ensured that the final grading meets the requirements specified in Table 7, Table 8 and Table 9.

Table 2 Limits of Deleterious Materials
(Clause 5.2.1)

Sl No.	Deleterious Substance	Method of Test, Ref to	Fine Aggregate Percentage by Mass, Max			Coarse Aggregate Percentage by Mass, Max		
			Uncrushed	Crushed/Mixed	Manufactured	Uncrushed	Crushed	Manufactured
(1)	(2)	(3)	(4)	(5)	(6)	(7)	(8)	(9)
i)	Coal and lignite	IS 2386 (Part 2)	1.00	1.00	1.00	1.00	1.00	1.00
ii)	Clay lumps	IS 2386 (Part 2)	1.00	1.00	1.00	1.00	1.00	1.00
iii)	Materials finer than 75 µm IS Sieve	IS 2386 (Part 1)	3.00	15.00 (for crushed sand) 12.00 (for mixed sand) <i>see Note 1)</i>	10.00	1.00	1.00	1.00
iv)	Soft fragments	IS 2386 (Part 2)	—	—	—	3.00	—	3.00
v)	Shale	(<i>see Note 2)</i>)	1.00	—	1.00	—	—	—
vi)	Total of percentages of all deleterious materials (except mica) including Sl No. (i) to (v) for col 4, 7 and 8 and Sl No. (i) and (ii) for col 5, 6 and 9	—	5.00	2.00	2.00	5.00	2.00	2.00

NOTES

1 The sands used for blending in mixed sand shall individually also satisfy the requirements of Table 2. The uncrushed sand used for blending shall not have material finer than 75 µm more than 3.00 percent.

2 When the clay stones are harder, platy and fissile, they are known as shales. The presence and extent of shales shall be determined by petrography at the time of selection and change of source.

3 The presence of mica in the fine aggregate has been found to affect adversely the workability, strength, abrasion resistance and durability of concrete. Where no tests for strength and durability are conducted, the mica in the fine aggregate may be limited to 1.00 percent by mass. Where tests are conducted to ensure adequate workability, satisfactory strength, permeability and abrasion (for wearing surfaces), the mica up to 3.00 percent by mass for muscovite type shall be permitted. In case of presence of both muscovite and biotite mica, the permissible limit shall be 5.00 percent, maximum by mass. This is subject to total deleterious materials (including mica) being limited to 8.00 percent by mass for col 4 and 5.00 percent for col 5.

Till a method is included in IS 2386 (Part 2), for determination of mica content, suitable methodology may be used for the same. Normally, petrographic density separation and wind blowing methods can be used.

4 The aggregate shall not contain harmful organic impurities [tested in accordance with IS 2386 (Part 2)] in sufficient quantities to affect adversely the strength or durability of concrete. A fine aggregate which fails in the testing of organic impurities may be used, provided that, when tested for the effect of organic impurities on the strength of mortar, the relative strength at 7 and 28 days, reported in accordance with IS 2386 (Part 6) is not less than 95 percent.

5.3 Combined Flakiness and Elongation Index

Flakiness and elongation shall be determined in accordance with IS 2386 (Part 1) on the same sample. After carrying out the flakiness index test, the flaky material shall be removed from the sample and the remaining portion shall be used for carrying out elongation index. Indices so worked out shall be added numerically to give combined flakiness and elongation index. The combined flakiness and elongation index so obtained shall not exceed 40 percent for uncrushed or crushed aggregate. However, the engineer-in-charge at his discretion may relax the limit keeping in view the requirement, and availability of aggregates and performance based on tests on concrete.

5.4 Mechanical Properties

5.4.1 Aggregate Crushing Value/Ten Percent Fines Value

The aggregate crushing value/ten percent fines value, when determined in accordance with IS 2386 (Part 4) shall be as follows:

- a) For aggregates to be : 30 percent, *Max* used in concrete for wearing surfaces, (such as runways, roads, pavements, tunnel lining carrying water, spillways and stilling basins)

- b) For aggregates to be used in concrete other than for wearing surfaces : In case the aggregate crushing value exceeds 30 percent, then the test for 'ten percent fines' should be conducted and the minimum load for the ten percent fines should be 50 kN

5.4.2 Aggregates Impact Value

As an alternative to 5.4.1, the aggregate impact value may be determined in accordance with the method specified in IS 2386 (Part 4). The aggregate impact value shall not exceed the following values:

- a) For aggregates to be used in concrete for wearing surfaces, (such as runways, roads, pavements, tunnel lining carrying water, spillways and stilling basins) : 30 percent
- b) For aggregates to be used in concrete other than for wearing surfaces : 45 percent

NOTE — For concrete of grades M 65 and above, stronger aggregates are required and hence the maximum aggregate crushing value and aggregate impact value shall not exceed 22 percent.

5.4.3 Aggregate Abrasion Value

The aggregate abrasion value, when determined in accordance with IS 2386 (Part 4) using Los Angeles machine, shall not exceed the following values:

- a) For aggregates to be used in concrete for wearing surfaces, (such as runways, roads, pavements, spillways, tunnel lining carrying water and stilling basins) : 30 percent
- b) For aggregates to be used in concrete other than for wearing surfaces : 50 percent

5.5 Soundness of Aggregate

5.5.1 For concrete liable to be exposed to the action of frost, the coarse and fine aggregates shall pass a sodium or magnesium sulphate accelerated soundness test specified in IS 2386 (Part 5), the limits being set by agreement between the purchaser and the supplier.

NOTE — As a general guide, it may be taken that the average loss of mass after 5 cycles shall not exceed the following:

- a) For fine aggregate : 10 percent when tested with sodium sulphate (Na₂SO₄), and 15 percent when testing with magnesium sulphate (MgSO₄)

- b) For coarse aggregate : 12 percent when tested with sodium sulphate (Na₂SO₄), and 18 percent when tested with magnesium sulphate (MgSO₄)

5.5.2 For slag aggregates, following additional tests shall be carried out:

- a) *Iron unsoundness* — When chemical analysis of aggregates shows that the ferrous oxide content is equal to or more than 3.0 percent, and sulphur content is equal to or more than 1.0 percent, the aggregate shall be tested for iron unsoundness. The iron unsoundness of the slag aggregate when tested as per the procedure given in Annex D, shall not exceed 1 percent.
- b) *Volumetric expansion ratio* — It shall not be more than 2.0 percent. The procedure shall be as given in Annex E.
- c) *Unsoundness due to free lime* — Prior to use of iron slag (for production of aggregates) from a new source or when significant changes in furnace chemistry occur in an existing source which may result in the presence of free lime, the potential for pop-out formation shall be assessed by determining the free-lime content of the slag by petrographic examination or quantitative x-ray diffractometry on a representative sample.

If the number of particles containing free lime exceeds 1 in 20, then weathering of the slag stockpile (in moist condition or at/near saturated surface dry condition) represented by the test sample shall be continued until further testing shows that the level has fallen below 1 in 20.

5.6 Alkali Aggregate Reaction

Some aggregates containing particular varieties of silica may be susceptible to attack by alkalis (Na₂O and K₂O) originating from cement and other sources, producing an expansive reaction which can cause cracking and disruption of concrete. Damage to concrete from this reaction will normally only occur when all the following are present together:

- a) A high moisture level within the concrete.
- b) A cement with high alkali content, or another source of alkali.
- c) Aggregate containing an alkali reactive constituent.

NOTE — The aggregates containing more than 20 percent strained quartz and undulatory extinction angle greater than 15°, causing deleterious reaction and also possibly showing presence of microcrystalline quartz is known as slowly reactive aggregates.

The aggregate shall comply with the requirements as follows, when tested in accordance with IS 2386 (Part 7):

- 1) **Chemical method** — The aggregate when tested in accordance with the chemical method, shall conform to the requirement as specified in IS 2386 (Part 7). If test results indicate deleterious or potentially deleterious character, the aggregate should be tested using mortar bar method as specified in IS 2386 (Part 7) to verify the potential for expansion in concrete. This chemical method (for determination of potential reactivity) however, is not found to be suitable for slowly reactive aggregates or for aggregate containing carbonates (limestone aggregates) or magnesium silicates, such as antigorite (serpentine). Therefore, petrographic analysis of aggregates shall be carried out to find out the strained quartz percentage, undulatory extinction angle and its mineral composition before conducting the test.
- 2) **Mortar bar method**
 - i) **Using 38°C temperature regime** — The permissible limits for mortar bar expansion at 38°C shall be 0.05 percent at 90 days and 0.10 percent at 180 days. For slowly reactive aggregates (as explained in NOTE above) mortar bar method using temperature regime of 38°C shall not be used for determination of potential reactivity. Such slowly reactive aggregates shall be tested using 60°C temperature regime. Therefore, petrographic analysis of aggregates shall be carried out to find out the strained quartz percentage, undulatory extinction angle and its mineral composition before conducting the test.
 - ii) **Using 60°C temperature regime** — The permissible limit mortar bar expansion at 60°C shall be 0.05 percent at 90 days and 0.06 percent at 180 days for slowly reactive aggregates.
- 3) **Accelerated mortar bar method** — The accelerated mortar bar test shall be carried out at 80°C using 1N NaOH. The test is found to be specially suitable for slowly reactive aggregate. The criteria for this test is as under:
 - i) Expansions of less than 0.10 percent at 16 days after casting are indicative of innocuous behavior in most cases (*see Note*).

NOTE — Some granitic gneisses and metabasalts have been found to be deleteriously expansive in field performance even though their expansion in this test was less than 0.10 percent at 16 days after casting. With such aggregate, it is recommended that prior field performance be investigated. In the

absence of field performance data, mitigative measures should be taken.

- ii) Expansions of more than 0.20 percent at 16 days after casting are indicative of potentially deleterious expansion [*see 4.2.2 of IS 2386 (Part 7)*].
- iii) Expansions between 0.10 and 0.20 percent at 16 days after casting include both aggregate that are known to be innocuous and deleterious in field performance. For these aggregate, it is particularly important to develop supplemental information as described in 4.2.2 of IS 2386 (Part 7). In such a situation, it may also be useful to take comparator reading until 28 days. It may be useful to support this test with test by mortar bar method at 38°C and 60°C, as applicable.

In few locations in the country, dolomitic and limestone aggregates are encountered. In such cases, concrete prism test shall be preferred over mortar bar test. The test should cover the determination by measurement of length change of concrete prisms, the susceptibility of cement-aggregate combinations to expansive alkali-carbonate reaction involving hydroxide ions associated with alkalis (sodium and potassium) and certain calcitic dolomites and dolomitic limestones. Till this test is included in IS 2386 (Part 7), specialist literature may be referred for the test and applicable requirement.

5.7 Manufactured aggregates shall meet the additional requirements as given in Table 3, Table 4, Table 5 and Table 6.

Table 3 Additional Requirements for all Manufactured Aggregates
(Clause 5.7)

Sl No. (1)	Characteristic (2)	Requirement (3)
i)	Total alkali content as Na ₂ O equivalent, percent, <i>Max</i>	0.3
ii)	Total sulphate content as SO ₃ , percent, <i>Max</i>	0.5
iii)	Acid soluble chloride content, percent, <i>Max</i>	0.04
iv)	Water absorption, percent, <i>Max</i>	5 (<i>see Note 1</i>)
v)	Specific gravity	2.1 to 3.2 (<i>see Notes 2 and 3</i>)

NOTES

1 For recycled concrete aggregate and recycled aggregate, higher water absorption up to 10 percent may be permitted subject to pre-wetting (saturation) of aggregates before batching and mixing.

2 The limits are intended for use of aggregate in normal weight concrete.

3 Copper slag having higher specific gravity (up to 3.8) shall be permitted for part replacement of aggregates in accordance with 4.2.1, such that the average specific gravity of the fine aggregate is not more than 3.2.

Table 4 Additional Requirements for Iron and Steel Slag Aggregates
(Clause 5.7)

Sl No. (1)	Characteristic (2)	Requirement (3)
i)	Calcium oxide as CaO, percent, <i>Max</i>	45.0
ii)	Total sulphur as S, percent, <i>Max</i>	2.0
iii)	Total iron as FeO, percent, <i>Max</i>	3.0

NOTE — Stockpiling of slag aggregate: Crushed slag aggregate should be stockpiled in moist condition at or near the saturated surface dry (SSD) condition before use, with the moisture condition being maintained by sprinkling with water.

Table 5 Additional Requirements for Electric Furnace Oxidation Slag Coarse Aggregate
(Clause 5.7)

Sl No. (1)	Characteristic (2)	Requirement (3)
i)	Calcium oxide as CaO, percent, <i>Max</i>	40
ii)	Magnesium oxide as MgO, percent, <i>Max</i>	10
iii)	Total iron as FeO, percent, <i>Max</i>	50
iv)	Basicity as CaO/SiO ₂ , percent, <i>Max</i>	2

Table 6 Additional Requirements for Copper Slag Aggregate
(Clause 5.7)

Sl No. (1)	Characteristic (2)	Requirement (3)
i)	Calcium oxide as CaO, percent, <i>Max</i>	12.0
ii)	Total sulphur as S, percent, <i>Max</i>	2.0
iii)	Total iron as FeO, percent, <i>Max</i>	70
iv)	Chlorine as NaCl, percent, <i>Max</i>	0.03

6 SIZE AND GRADING OF AGGREGATES

6.1 Single-Sized Coarse Aggregates

Coarse aggregates shall be supplied in the nominal sizes given in Table 7. For any one of the nominal sizes, the

proportion of other sizes, as determined by the method described in IS 2386 (Part 1) shall also be in accordance with Table 7.

6.1.1 Coarse Aggregate for Mass Concrete

Coarse aggregate for mass concrete works shall be in the sizes specified in Table 8.

6.2 Graded Coarse Aggregates

Graded coarse aggregates may be supplied in the nominal sizes given in Table 7.

6.3 Fine Aggregate

The grading of fine aggregate, when determined as described in IS 2386 (Part 1) shall be within the limits given in Table 9 and shall be described as fine aggregate, Grading Zones I, II, III and IV. Where the grading falls outside the limits of any particular grading zone of sieves other than 600 µm IS Sieve by an amount not exceeding 5 percent for a particular sieve size, (subject to a cumulative amount of 10 percent), it shall be regarded as falling within that grading zone. This tolerance shall not be applied to percentage passing the 600 µm IS Sieve or to percentage passing any other sieve size on the coarse limit of Grading Zone I or the finer limit of Grading Zone IV.

6.4 All-in-Aggregate

If combined aggregates are available they need not be separated into fine and coarse. The grading of the all-in-aggregate, when analyzed, as described in IS 2386 (Part 1) shall be in accordance with Table 10. Necessary adjustments may be made in the grading by the addition of single-sized aggregates

7 SAMPLING AND TESTING

7.1 Sampling

The method of sampling shall be in accordance with

Table 7 Coarse Aggregates
(Clauses 6.1 and 6.2)

Sl No. (1)	IS Sieve Designation (2)	Percentage Passing for Single-Sized Aggregate of Nominal Size						Percentage Passing for Graded Aggregate of Nominal Size			
		63 mm (3)	40 mm (4)	20 mm (5)	16 mm (6)	12.5 mm (7)	10 mm (8)	40 mm (9)	20 mm (10)	16 mm (11)	12.5 mm (12)
i)	80 mm	100	-	-	-	-	-	100	-	-	-
ii)	63 mm	85 to 100	100	-	-	-	-	-	-	-	-
iii)	40 mm	0 to 30	85 to 100	100	-	-	-	90 to 100	100	-	-
iv)	20 mm	0 to 5	0 to 20	85 to 100	100	-	-	30 to 70	90 to 100	100	100
v)	16 mm	-	-	-	85 to 100	100	-	-	-	90 to 100	-
vi)	12.5 mm	-	-	-	-	85 to 100	100	-	-	-	90 to 100
vii)	10 mm	0 to 5	0 to 5	0 to 20	0 to 30	0 to 45	85 to 100	10 to 35	25 to 55	30 to 70	40 to 85
viii)	4.75 mm	-	-	0 to 5	0 to 5	0 to 10	0 to 20	0 to 5	0 to 10	0 to 10	0 to 10
ix)	2.36 mm	-	-	-	-	-	0 to 5	-	-	-	-

Table 8 Sizes of Coarse Aggregates for Mass Concrete
(Clause 6.1.1)

Sl No. (1)	Class and Size (2)	IS Sieve Designation (3)	Percentage Passing (4)
i)	Very large, 150 to 80 mm	160 mm	90 to 100
		80 mm	0 to 10
ii)	Large, 80 to 40 mm	80 mm	90 to 100
		40 mm	0 to 10
iii)	Medium, 40 to 20 mm	40 mm	90 to 100
		20 mm	0 to 10
iv)	Small, 20 to 4.75 mm	20 mm	90 to 100
		4.75 mm	0 to 10
		2.36 mm	0 to 0.2

Table 9 Fine Aggregates
(Clause 6.3)

Sl No. (1)	IS Sieve Designation (2)	Percentage Passing			
		Grading Zone I (3)	Grading Zone II (4)	Grading Zone III (5)	Grading Zone IV (6)
i)	10 mm	100	100	100	100
ii)	4.75 mm	90-100	90-100	90-100	95-100
iii)	2.36 mm	60-95	75-100	85-100	95-100
iv)	1.18 mm	30-70	55-90	75-100	90-100
v)	600 µm	15-34	35-59	60-79	80-100
vi)	300 µm	5-20	8-30	12-40	15-50
vii)	150 µm	0-10	0-10	0-10	0-15

NOTES

1 For crushed stone sands, the permissible limit on 150 µm IS Sieve is increased to 20 percent. This does not affect the 5 percent allowance permitted in 6.3 applying to other sieve sizes.

2 Fine aggregate complying with the requirements of any grading zone in this table is suitable for concrete but the quality of concrete produced will depend upon a number of factors including proportions.

3 As the fine aggregate grading becomes progressively finer, that is, from Grading Zones I to IV, the ratio of fine aggregate to coarse aggregate should be progressively reduced. The most suitable fine to coarse ratio to be used for any particular mix will, however, depend upon the actual grading, particle shape and surface texture of both fine and coarse aggregates.

4 It is recommended that fine aggregate conforming to Grading Zone IV should not be used in reinforced concrete unless tests have been made to ascertain the suitability of proposed mix proportions.

IS 2430. The amount of material required for each test shall be as specified in the relevant method of test given in IS 2386 (Part 1) to IS 2386 (Part 8).

7.2 Chemical tests like alkalis (Na_2O equivalent), sulphate (SO_3), calcium oxide, sulphur (S), iron (FeO), magnesium oxide (MgO), silica (SiO_2) and chlorine (NaCl), can be carried out as per IS 4032 and water soluble chloride test can be carried out as per IS 14959 (Part 2). All other tests shall be carried out as described in IS 2386 (Part 1) to IS 2386 (Part 8) and in this standard.

7.2.1 In the case of all-in-aggregate, for the purpose of tests to verify its compliance with the requirements given in Table 2, and when necessary for such other tests as required by the purchaser, the aggregate shall be first separated into two fractions, one finer than 4.75 mm IS Sieve and the other coarser than 4.75 mm IS Sieve, and the appropriate tests shall be made on samples from each component, the former being tested as fine aggregate and the latter as coarse aggregate.

Table 10 All-in-Aggregate Grading
(Clause 6.4)

Sl No. (1)	IS Sieve Designation (2)	Percentage Passing for All-in-Aggregate of	
		40 mm Nominal Size (3)	20 mm Nominal Size (4)
i)	80 mm	100	—
ii)	40 mm	95 to 100	100
iii)	20 mm	45 to 75	95 to 100
iv)	4.75 mm	25 to 45	30 to 50
v)	600 µm	8 to 30	10 to 35
vi)	150 µm	0 to 6	0 to 6

8 SUPPLIER'S CERTIFICATE AND COST OF TESTS

8.1 The supplier shall satisfy himself that the material complies with the requirements of this standard and, if requested, shall supply a certificate to this effect to the purchaser.

8.2 If the purchaser requires independent tests to be made, the sample for such tests shall be taken before or immediately after delivery according to the option of the purchaser, and the tests carried out in accordance with this standard and on the written instructions of the purchaser.

8.3 The supplier shall supply free of charge, the material required for tests.

8.4 The cost of the tests carried out under 8.2 shall be borne by,

- the supplier, if the results show that the material does not comply with this standard; and
- the purchaser, if the results show that the material complies with this standard.

9 DELIVERY

9.1 Supplies of aggregate may be made in bulk in suitable quantities mutually agreed upon between the purchaser and the supplier. Where so required by the purchaser, the aggregate may be supplied in bags (jute, jute-laminated, polyethylene lined or as may be mutually agreed between the purchaser and the supplier) bearing the net quantity (may be 25 kg, 50 kg, 300 kg,

600 kg or as agreed to between the purchaser and the supplier). The tolerance on the quantity of aggregate in each bag or consignment shall be as per 9.2 unless mutually agreed upon between the purchaser and the supplier.

9.2 Tolerance Requirements for the Quantity of Aggregate Packed in Bags

9.2.1 The average of net quantity of aggregate packed in bags at the plant in a sample shall be equal to or more than 25 kg, 50 kg, 300 kg, 600 kg, etc, as applicable. The number of bags in a sample shall be as given below:

<i>Batch Size</i>	<i>Sample Size</i>
100 to 150	20
151 to 280	32
281 to 500	50
501 to 1 200	80
1 201 to 3 200	125
3 201 and over	200

The bags in a sample shall be selected at random (see IS 4905).

9.2.2 The number of bags in a sample showing a minus error greater than 2 percent of the specified net quantity shall be not more than 5 percent of the bags in the sample. Also the minus error in none of such bags in the sample shall exceed 4 percent of the specified net quantity of aggregate in the bag.

9.2.3 In case of a wagon or truck load of 5 to 25 t, the overall tolerance on net quantity of aggregate shall be 0 to + 0.5 percent.

10 MARKING

10.1 Each consignment/bag of aggregate shall be

legibly and indelibly marked with the following information:

- a) Manufacturer's name and his registered trademark, if any;
- b) Net quantity, in kg;
- c) Words 'Use no Hooks' on the bags;
- d) Batch/control unit number;
- e) Address of the manufacturer;
- f) Month and year of consignment/packing;
- g) Type of aggregate, such as 'Coarse Aggregate' or 'Fine Aggregate';
- h) In case the aggregates are from natural sources, the words 'Natural Aggregate';
- j) In case of aggregates from other than natural sources, the type of coarse/fine aggregate (see Table 1);
- k) In case of coarse aggregate, the nominal size along with the words, 'Single Sized' or 'Graded', as the case may be; and
- m) In case of fine aggregate, the grading zone.

10.2 Similar information shall be provided in the delivery advices accompanying the shipment of aggregate in bulk (see 10.3).

10.3 BIS Certification Marking

The aggregate may also be marked with the Standard Mark.

10.3.1 The use of the Standard Mark is governed by the provisions of the *Bureau of Indian Standards Act, 1986* and the Rules and Regulations made thereunder. The details of conditions under which a license for the use of the Standard Mark may be granted to manufacturers or producers may be obtained from the Bureau of Indian Standards.

ANNEX A

(Foreword)

BRIEF INFORMATION ON AGGREGATES FROM OTHER THAN NATURAL SOURCES

A-1 IRON AND STEEL SLAG AGGREGATES

A-1.1 Iron Slag Aggregate

A-1.1.1 Iron slag is obtained as a byproduct, while producing iron in blast furnaces or basic oxygen furnaces in integrated iron and steel plants. The lime in the flux chemically combines with the aluminates and silicates of the iron ore and coke ash to form a non-metallic product called iron/blast furnace slag. The molten slag at a temperature of approximately 1 500°C is taken out of the furnace and cooled to form different types of slag products.

A-1.1.2 Air Cooled Iron Slag Aggregate

Molten slag is allowed to flow from the furnace into open pits located beside the furnaces where the material is quenched with water to facilitate cooling and crystallization. The slag after cooling can be further crushed and screened to produce different sizes of aggregates. During its usage, care should be taken to ensure that the slag passes the test for 'iron unsoundness' and is pre-wetted prior to its use. Figure 1 shows typical air-cooled iron slag aggregate.

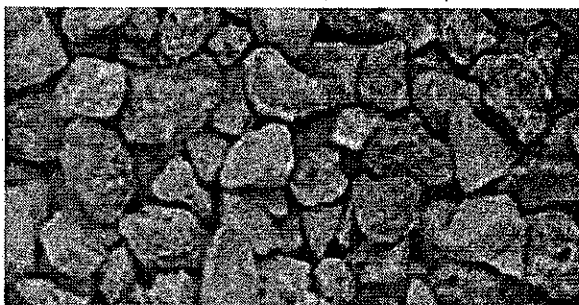

FIG. 1 AIR COOLED IRON SLAG AGGREGATE

A-1.1.3 Granulated Iron Slag Aggregate

In this case, molten slag is allowed to flow through the launders into a granulation plant, where molten slag is quenched rapidly with large volume of water. This results in vitrified (glassy) material with a sand-like appearance, with particles typically 1 mm to 5 mm size. It is a light weight aggregate, which needs further processing to improve the bulk density to more than 1.35 kg/l for its use as normal weight aggregate. Figure 2 shows typical granulated iron slag aggregate.

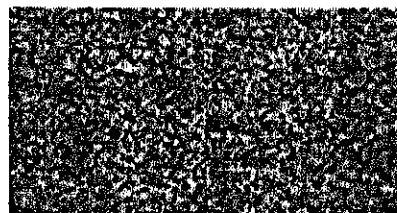

FIG. 2 GRANULATED IRON SLAG AGGREGATE

A-1.2 Steel Slag Aggregate

Steel slag is a byproduct produced in steel making operations in integrated iron and steel plants. The calcined lime used as flux combines with the silicates, aluminum oxides, magnesium oxides, manganese oxides and ferrites to form steel furnace slag, commonly called steel slag. Slag is poured in a cooling yard from the furnace at a temperature of 1 400 °C - 1 700 °C and cooled by air and sprinkling of water. Steelmaking slag contains about 10 to 20 metallic iron percent by mass, and is recovered by magnetic separation. The metal free slag is crushed and screened to different sizes for use as aggregates. For use as aggregates, the steel slag is subjected to weathering process (natural or accelerated) to reduce the free lime content in the slag. Figure 3 shows typical steel slag aggregate.

NOTE — Air Cooled Blast furnace Slag (ACBFS) has unique chemical and physical properties that influence its behaviour as an aggregate in concrete. Several of the key chemical properties are provided but the physical property of greatest concern is the high level of porosity compared to that present in naturally derived aggregates, which contributes to high absorption capacities. This is important during construction, as the moisture condition of the aggregate will impact workability and early-age, shrinkage-related cracking, if the aggregate is not kept sufficiently moist prior to batching. It may also have long-term ramifications on in service durability, depending on the level of saturation those aggregates are subjected to either at the bottom of the slabs or in the vicinity of joints and cracks.

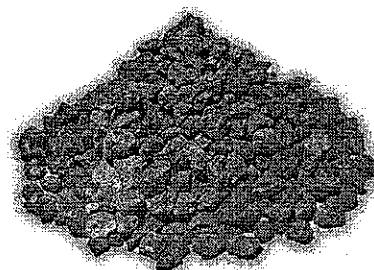

FIG. 3 STEEL SLAG AGGREGATE

A-2 COPPER SLAG AS AGGREGATES

Copper slag is produced as a byproduct from copper smelter, while producing copper from copper concentrate (copper pyrite) through pyrometallurgical process. In the process of smelting, the iron present in the copper concentrate combines chemically at 1 200°C with silica present in flux materials such as river sand/silica sand/quartz fines to form iron silicate, which is termed as copper slag. The copper slag thus generated is quenched with water to produce granulated copper slag.

Copper slag is a blackish granular material, similar to medium to coarse sand having size ranging from 150 µm to 4.75 mm. This aggregate has potential for use as fine aggregate in accordance with provisions of this standard (see Fig. 4).

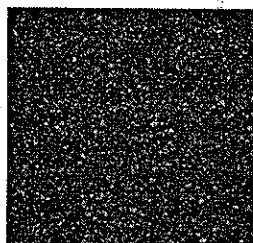

FIG. 4 TYPICAL COPPER SLAG AGGREGATE

A-3 CONSTRUCTION AND DEMOLITION (C&D) WASTE

Use of construction and demolition (C&D) waste for manufacture of aggregates is a step towards effective management and utilization of this waste. This however, requires necessary care while producing aggregates to ensure their efficacy in their use as part of concrete. These aggregates may be of two types namely Recycled Aggregate (RA) and Recycled Concrete Aggregate (RCA). RA is made from C&D waste which may comprise concrete, brick, tiles, stone, etc, and RCA is derived from concrete after requisite processing.

Recycled concrete aggregate (RCA) contain not only the original aggregate, but also hydrated cement paste adhering to its surface. This paste reduces the specific gravity and increases the porosity compared to similar virgin aggregates. Higher porosity of RCA leads to a higher absorption. Recycled aggregate (RA) will typically have higher absorption and lower specific gravity than natural aggregate. The concrete rubble has to be properly processed, including scrubbing to remove the adhered hydrated cement as much as possible.

The broad steps involved in the manufacture of aggregates from C&D waste may be:

- a) Receipt and inspection of C&D waste at the plant.
- b) Weighing of waste.

- c) Mechanical and manual segregation and resizing - this may involve segregation of various types of wastes such as bricks, stones, concrete, steel, tiles, etc.

- d) Dry and wet processing.

Figure 5, Figure 6A and Figure 6B show typical C&D waste, recycled concrete aggregate and recycled aggregate obtained there from.

RA can be used as coarse aggregate and RCA can be used as coarse and fine aggregates in accordance with this standard.

A-4 ENVIRONMENTAL SAFETY AND QUALITY STANDARDS USING IRON AND STEEL AND COPPER SLAG AGGREGATES

The engineer-in-charge may get the iron and steel and copper slag aggregates checked for hazardous substances, at appropriate frequency. Specialist literature may be referred for the test method, the technique commonly in use are Inductively Coupled Plasma (ICP) spectroscopy and Atomic Absorption Spectrophotometer (AAS). As a guide the values given in Table 11 may be followed as the permissible values.



FIG. 5. DEMOLITION WASTE BEFORE PROCESSING

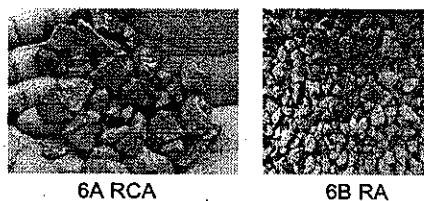

FIG. 6 RECYCLED CONCRETE AGGREGATE AFTER PROCESSING AND RECYCLED AGGREGATE AFTER PROCESSING

Table 11 Environmental Safety and Quality Standards Using Iron and Steel and Copper Slag Aggregates (Clause A-4)

Sl No. (1)	Item (2)	Elution volume, Max mg/kg (3)	Content, Max, mg/l (4)
i)	Cadmium	0.01	150
ii)	Lead	0.01	150
iii)	Hexavalent chromium	0.05	250
iv)	Arsenic	0.01	150
v)	Mercury	0.000 5	15
vi)	Selenium	0.01	150
vii)	Fluorine	0.8	4 000
viii)	Boron	1	4 000

ANNEX B

(Foreword)

INFORMATION TO BE FURNISHED BY THE SUPPLIER

B-1 DETAILS OF INFORMATION

When requested by the purchaser or his representative, the supplier shall provide the following particulars:

- | | |
|--------------------------------------------------------------------------------------------------------------------------------------------------------------------------------------------------------------------------------------------------------------------------------------------------------------------------------------------------------------------------------------------------------------------------------------------------------------------------------------|----------------------------------------------------------------------------------------------------------------------------------------------------------------------------------------------------------------------------------------------------------------------------------------------------------------------------------------------------------------------------------------------------------|
| <ul style="list-style-type: none"> a) Source of supply, that is, precise location of source from where the materials were obtained; b) Trade group of principal rock type present, in case of aggregates from natural sources (<i>see Annex C</i>); c) Physical characteristics, in case of aggregates from natural sources (<i>see Annex C</i>); d) In case of manufactured aggregates, the brief manufacturing process, source of parent | <ul style="list-style-type: none"> e) Presence of reactive minerals; f) Service history, if any and in particular, in case of manufactured aggregates, the name of projects where used and the performance including in recently completed projects; and g) In case of manufactured aggregates, special precautions, if any, to be observed during concrete production. |
|--------------------------------------------------------------------------------------------------------------------------------------------------------------------------------------------------------------------------------------------------------------------------------------------------------------------------------------------------------------------------------------------------------------------------------------------------------------------------------------|----------------------------------------------------------------------------------------------------------------------------------------------------------------------------------------------------------------------------------------------------------------------------------------------------------------------------------------------------------------------------------------------------------|

material and special characteristics having bearing on concrete properties, such as presence of adhered coating in case of recycled concrete aggregate, to the extent possible.

ANNEX C

(Clause B-1.1)

DESCRIPTION AND PHYSICAL CHARACTERISTICS OF AGGREGATES FROM NATURAL SOURCES, FOR CONCRETE

C-1 GENERAL HEADINGS

To enable detailed reports on aggregate, the petrographic examination as per IS 2386 (Part 8) may be carried out and information in the following general headings may be given, are suggested as a guide:

- a) *Trade group* — For example, granite, limestone and sandstone (*see C-2.2*);
- b) *Petrological name and description* — The correct petrological name should be used and should be accompanied by a brief description of such properties as hardness, colour, grain, imperfections, etc;
- c) *Description of the bulk* — The degree of cleanliness, that is, freedom from dust, should be stated and reference made to the presence of any pieces not representative of the bulk;
- d) *Particle shapes* — *See C-3*; and
- e) *Surface texture* — *See C-3*.

C-2 NOMENCLATURE OF ROCK

C-2.1 The technical nomenclature of rocks is an extensive one and for practical purposes it is sufficient to group together with those rocks having certain petrological characteristics in common. Accordingly, the list of trade groups given in **C-2.2** is adopted for the convenience of producers and users of aggregates.

C-2.2 Trade Groups of Rocks Used as Concrete Aggregate

The list of rocks placed under appropriate trade groups is given below:

a) IGNEOUS ROCKS

1) *Granite Group*

Granite	Granodiorite
Gmnophyre	Diorite
	Syenite

- 2) *Gabbro Group*
 - Gabbro Peridotite
 - Norite Pyroxenite
 - Anorthosite Epidiorite
 - 3) *Aplite Group*
 - Aplite Quartz reef
 - Porphyry
 - 4) *Dolerite Group*
 - Dolerite Lamprophyre
 - 5) *Rhyolite Group*
 - Rhyolite Felsite
 - Trachyte Pumicite
 - 6) *Basalt Group*
 - Andesite Basalt
- b) **SEDIMENTARY ROCKS**
- 1) *Sandstone Group*
 - Sandstone Arkose
 - Quartzite Graywacke
 - Grit
 - 2) *Limestone Group*
 - Limestone Dolomite
- c) **METAMORPHIC ROCKS**
- 1) *Granulite and Gneiss Groups*
 - Granite gneiss Amphibolite
 - Composite gneiss Granulite
 - 2) *Schist Group*
 - Slate Phyllite
 - Schist
 - 3) *Marble Group*
 - Marble Crystalline limestone

The correct identification of a rock and its placing under the appropriate trade group shall be left to the decision of the Geological Survey of India or any competent geologist.

C-3 PARTICLE SHAPE AND SURFACE TEXTURE

C-3.1 The external characteristics of any mixture of mineral aggregate include a wide variety of physical shape, colour and surface condition. In order to avoid lengthy descriptions, it may be convenient to apply to distinctive group types of aggregates some general term which could be adopted.

C-3.2 The simple system shown in Table 12 and Table 13 has, therefore, been devised for facilitate defining the essential features of both particle shape and surface characteristics.

Table 12 Particle Shape
(Clause C-3.2)

SI No.	Classification	Description	Illustrations of Characteristic Specimens	Example
(1)	(2)	(3)	(4)	(5)
i)	Rounded	Fully water worn or completely shaped by attrition	Fig. 7	River or seashore gravels; desert, seashore and windblown sands
ii)	Irregular or partly rounded	Naturally irregular, or partly shaped by attrition, and having rounded edges	Fig. 8	Pit sands and gravels; land or dug flints; cuboid rock
iii)	Angular	Possessing well-defined edges formed at the intersection of roughly planar faces	Fig. 9	Crushed rocks of all types; talus; screes
iv)	Flaky	Material, usually angular, of which the thickness is small relative to the width and/or length	Fig. 10	Laminated rocks

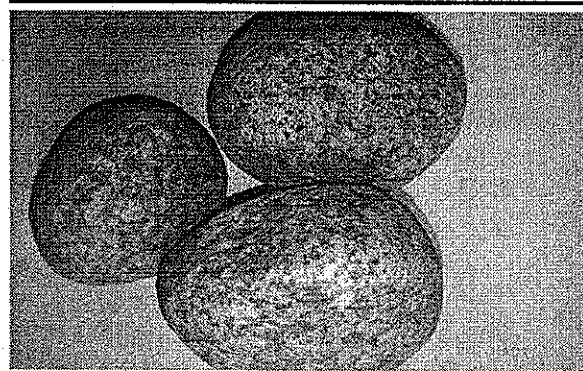

FIG. 7 PARTICLE SHAPE - ROUNDED

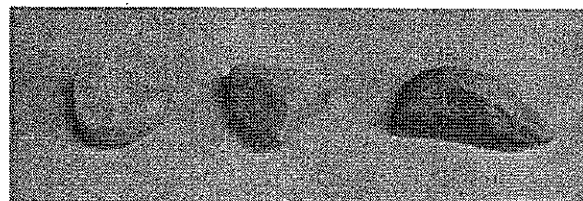

FIG. 8 PARTICLE SHAPE - IRREGULAR



FIG. 9 PARTICLE SHAPE - ANGULAR



FIG. 10 PARTICLE SHAPE - FLAKY

C-3.3 Surface characteristics have been classified under five groups in Table 13. The grouping is broad; it does not purport to be a precise petrographical classification

but is based upon a visual examination of hand specimens. With certain materials, however, it may be necessary to use a combined description with more than one group number for an adequate description of the surface texture, for example, crushed gravel 1 and 2; oolites 3 and 5.

Table 13 Surface Characteristics of Aggregates
(Clause C-3.2)

Sl No. (1)	Group (2)	Surface Texture (3)	Example (4)
i)	1	Glassy	Black flint
ii)	2	Smooth	Chert, slate, marble, some rhyolite
iii)	3	Granular	Sandstone, oolites
iv)	4	Crystalline	a) <i>Fine</i> — Basalt, trachyte, keratophyre b) <i>Medium</i> — Dolerite, granophyre, granulite, microgranite, some limestones, many dolomites c) <i>Coarse</i> — Gabbro, gneiss, granite, granodiorite, syenite
v)	5	Honey-combed and porous	Scoriae, pumice, trass

ANNEX D

[Clause 5.5.2 (a)]

DETERMINATION OF IRON UNSOUNDNESS FOR SLAG AGGREGATES

D-1 Some slags containing more than 3 percent ferrous oxide (FeO) will disintegrate on immersion in water when the sulphur (S) content of the slag is 1 percent or more. Aggregates derived from such slags show iron unsoundness.

D-2 PROCEDURE

Take randomly two test samples of not less than 50 pieces each of aggregate passing 40 mm and retained on 20 mm IS sieve. Immerse the pieces of first sample in distilled or deionized water at room temperature for a period of 14 days. Remove the pieces from the water at the end of the 14 day period and examine them.

D-3 CRITERIA FOR CONFORMITY

If no piece develops the following unsoundness during the storage period, the slag aggregate shall be deemed

to be free from iron unsoundness:

- a) Cracking (development of a visible crack),
- b) Disintegration (physical breakdown of aggregate particle),
- c) Shaling (development of fretting or cleavage of the aggregate particle), or
- d) Craze cracking at the surface of the aggregate.

The second test sample shall be tested, if any of the pieces (in the above sample) shows cracking, disintegration, shaling or craze cracking at the surface of the aggregate. If not more than one in one hundred pieces (1 percent) of the two test samples tested shows cracking, disintegration, shaling or craze cracking at the surface of the aggregate, the slag shall be regarded as free from iron unsoundness.

ANNEX E

[Clause 5.5.2 (b)]

DETERMINATION OF VOLUMETRIC EXPANSION RATIO OF SLAG AGGREGATES

E-1 This test specifies the procedure to calculate the volumetric expansion ratio for the evaluation of the potential expansion of aggregates like steel slag due to hydration reactions. This method can also be used to evaluate the effectiveness of weathering processes for reducing the expansive potential of such aggregate materials.

E-2 APPARATUS AND TOOLS

- a) *Moulds with base plate, stay rod and wing nut, perforated plate* — These shall conform to 4.1, 4.3 and 4.4 of IS 9669.
- b) *Metal Rammer* — As specified in 5.1 of IS 9198.
- c) *Curing apparatus* — The curing apparatus shall be a thermostat water tank, capable of holding not less than two 15 cm moulds, and able to keep the water temperature at $80 \pm 3^\circ\text{C}$ for 6 h.
- d) *Sieves* — These shall be 31.5 mm, 26.5 mm, 13.2 mm, 4.75 mm, 2.36 mm, 500 μm and 75 μm IS sieves.
- e) *Expansion measuring apparatus* — The expansion measuring apparatus shall be as shown in Fig. 11.

E-3 SAMPLE**E-3.1 Preparation of Sample**

The samples of slag shall be collected so as to represent the whole lot. The samples shall be prepared to meet the grading requirement given in Table 14.

Table 14 Grading Distribution
(Clause E-3.1)

SI No. (1)	Sieve Size (2)	Percentage Passing (3)
i)	31.5 mm	100
ii)	26.5 mm	97.5
iii)	13.2 mm	70
iv)	4.75 mm	47.3
v)	2.36 mm	35
vi)	500 μm	20
vii)	75 μm	6

E-3.2 Adjustment of Sample

The adjustment of sample shall be as follows:

- a) Add water to approximately 30 kg of sample

so that the difference between the moisture content and the optimum moisture content is within 1 percent. Mix it well to make moisture content uniform, and keep it for not less than 24 h.

- b) Reduce the above sample and obtain the sample necessary for making three specimens.

E-4 TEST PROCEDURE**E-4.1 Specimen Preparation**

The specimens shall be prepared as follows:

- a) Attach collar and perforated base plate to the mould, put spacer disc in it, and spread a filter paper on it.
- b) The measurement of moisture content shall be conducted on two samples, each sample weighing not less than 500 g. When the measured value of moisture content differs from the value of optimum moisture ratio by not less than 1 percent, new specimens shall be prepared for curing.
- c) Pour the samples prepared as in E-3.2, in the mould with a scoop keeping a falling height of approximately 50 mm and ram the sample into three layers one upon another so that the depth of each layer after ramming is nearly equal to one another.
- d) Ram the layer uniformly by free dropping of the rammer 92 times from a height of 450 mm above each rammed surface. The ramming shall be performed on a rigid and flat foundation such as a concrete floor.
- e) Rammed surfaces shall be scratched slightly with a sharp ended steel bar for securing adhesion between layers.
- f) After finishing the ramming, remove the collar, shave out the excess sample stuck on upper part of the mould with a straight knife carefully. At this time, holes on the surface due to the removing of coarse grade materials shall be filled with fine grade materials, and the top surface shall be reformed.
- g) Turn the mould upside down gently pushing the reformed top surface with a lid so that the specimen in the mould does not decay or drop down, then remove the perforated base plate and take out the spacer-disc.
- h) Spread a filter paper on the perforated base

- plate, turn the mould upside down gently again, connect to the perforated base plate again for securing adhesion to the filter paper.
- j) Wipe off the materials of the specimen stuck on the outside of the mould and the perforated base plate, and measure the total mass.
 - k) From the sum of masses of the rammed specimen, the mould and the perforated base plate, subtract the masses of the mould and the perforated base plate, and divide it by the volume of the mould, which gives the wet density of the rammed specimen.

E-4.2 Curing and Measuring Operation of the Specimen

The curing and measuring operation of the specimen shall be as follows:

- a) Place the perforated plate with shaft on the filter paper which is spread on the top surface of the specimen in the mould.
- b) Install the dial-gauge and the attaching device (gauge holder) correctly. As shown in Fig. 11, dip it in the curing apparatus, and record the first reading of the dial-gauge after the mould reaches equilibrium with respect to the water bath.
- c) For curing, keep it at $80 \pm 3^\circ\text{C}$ for 6 h, then leave it to cool in the curing apparatus.
- d) Repeat the operation E-4.2 (c), one time per day for 10 days.

- e) On finishing of the curing period, record the last reading of the dial-gauge, remove the gauge holder and the dial-gauge, take out the mould from water, tilt it gently with the perforated plate with shaft on it, and remove the accumulated water. Then, after leaving quietly for 15 min, remove the filter paper and measure the mass.

E-5 CALCULATION

The calculation of volumetric expansion ratio shall be made as follows:

- a) The volumetric expansion ratio shall be calculated by the following formula, and be rounded off to the first decimal place:

$$E = 100 \times (D_f - D_i) / H$$

where

- E = volumetric expansion ratio, percent,
 D_f = last reading of the dial-gauge in mm,
 D_i = first reading of the dial-gauge in mm,
 and
 H = initial height of the specimen (125 mm).

- b) The test shall be carried out on three specimens prepared from the sample taken at the same time in accordance with E-3.2, and the average of the three test results shall be taken. The averaged value shall be rounded off to the first decimal place.

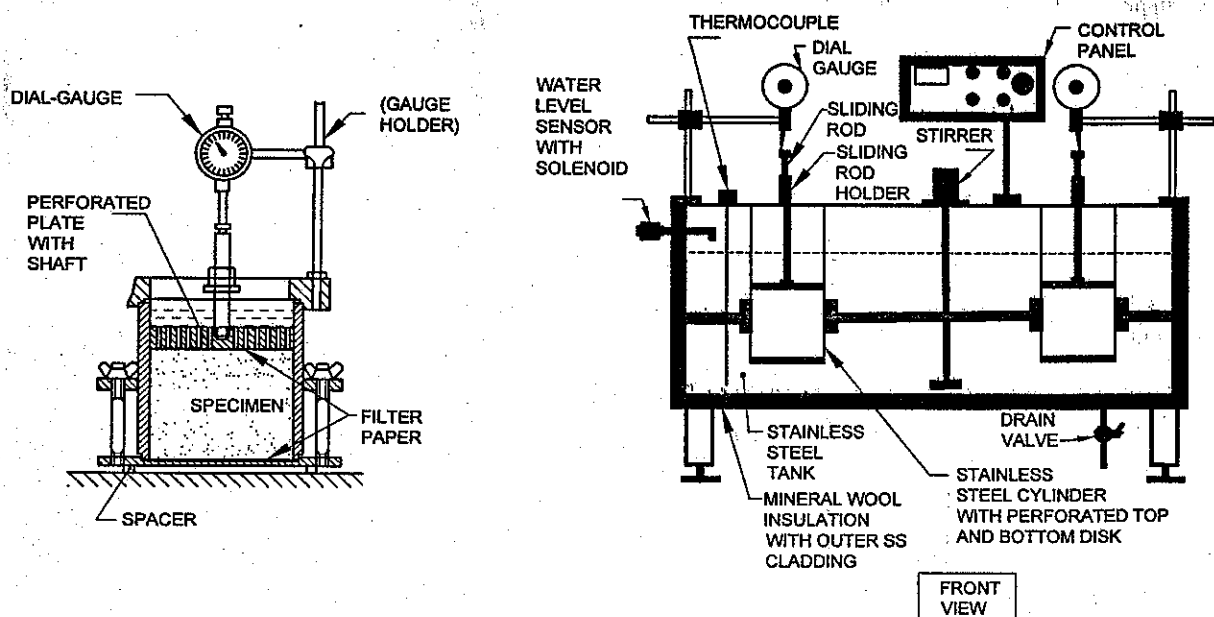

FIG 11: TEST SETUP FOR VOLUMETRIC EXPANSION TEST

ANNEX F

(Foreword)

COMMITTEE COMPOSITION

Cement and Concrete Sectional Committee, CED 02

<i>Organization</i>	<i>Representative(s)</i>
In Personal Capacity (7A, Autumn Hue, Seasons, PPD Apartments, Kuravankonam, Trivandrum)	SHRI JOSE KURIAN (<i>Chairman</i>)
ACC Ltd, Mumbai	SHRI S. A. KHADILKAR SHRI RAMAN SADANAND PARULEKAR (<i>Alternate</i>)
Ambuja Cements Limited, Mumbai	SHRI J. P. DESAI SHRI C. M. DORDI (<i>Alternate</i>)
Atomic Energy Regulatory Board, Mumbai	SHRI L. R. BISHNOI SHRI SAURAV ACHARYA (<i>Alternate</i>)
Builders' Association of India, Mumbai	SHRI SUSHANTA KUMAR BASU SHRI D. R. SEKAR
Building Materials and Technology Promotion Council, New Delhi	SHRI J. K. PRASAD SHRI C. N. JHA (<i>Alternate</i>)
Cement Manufacturers' Association, Noida	DR K. C. NARANG DR S. K. HANDOO (<i>Alternate</i>)
CSIR-Central Building Research Institute, Roorkee	SHRI S. K. SINGH SHRI SUBHASH GURRAM (<i>Alternate</i>)
CSIR-Central Road Research Institute, New Delhi	DR RAKESH KUMAR
CSIR-Structural Engineering Research Centre, Chennai	DR K. RAMANJANEYULU SHRI P. SRINIVASAN (<i>Alternate</i>)
Central Public Works Department, New Delhi	SHRI A. K. GARG SHRI RAJESH KHARE (<i>Alternate</i>)
Central Soil and Materials Research Station, New Delhi	SHRI MURARI RATNAM SHRI S. L. GUPTA (<i>Alternate</i>)
Central Water Commission, New Delhi	DIRECTOR (CMDD)(N&W) DEPUTY DIRECTOR (CMDD) (NW&S) (<i>Alternate</i>)
Conmat Technologies Pvt Ltd, Kolkata	DR A. K. CHATTERJEE
Construction Chemicals Manufacturers' Association, Mumbai	SHRI SAMIR SURLAKER SHRI UPEN PATEL (<i>Alternate</i>)
Delhi Development Authority, New Delhi	CHIEF ENGINEER (QAC) DIRECTOR (MATERIAL MANAGEMENT) (<i>Alternate</i>)
Engineers India Limited, New Delhi	SHRI RAJANJI SRIVASTAVA SHRI ANURAG SINHA (<i>Alternate</i>)
Fly Ash Unit, Department of Science and Technology, New Delhi	SHRI CHANDER MOHAN
Gammon India Limited, Mumbai	SHRI VENKATARAMANA N. HEGGADE SHRI MANISH MOKAL (<i>Alternate</i>)
Hindustan Construction Company Ltd, Mumbai	DR CHETAN HAAZAREE SHRI MANOHAR CHERALA (<i>Alternate</i>)
Housing and Urban Development Corporation Limited, New Delhi	SHRI DEEPAK BANSAL
Indian Association of Structural Engineers, New Delhi	PROF MAHESH TANDON SHRI GANESH JUNEJA (<i>Alternate</i>)
Indian Concrete Institute, Chennai	SHRI VIVEK NAIK SECRETARY GENERAL (<i>Alternate</i>)
Indian Institute of Technology Madras, Chennai	DR DEVDAS MENON DR MANU SANTHANAM (<i>Alternate</i>)
Indian Institute of Technology Roorkee, Roorkee	DR V. K. GUPTA DR BHUPINDER SINGH (<i>Alternate</i>)

<i>Organization</i>	<i>Representative(s)</i>
Indian Roads Congress, New Delhi	SECRETARY GENERAL DIRECTOR (<i>Alternate</i>)
Institute for Solid Waste Research & Ecological Balance, Visakhapatnam	DR N. BHANUMATHIDAS SHRI N. KALIDAS (<i>Alternate</i>)
Lafarge India Pvt Ltd, Mumbai	MS MADHUMITA BASU SHRI YAGYESH KUMAR GUPTA (<i>Alternate</i>)
Military Engineer Services, Engineer-in-Chief's Branch, Army HQ, New Delhi	MAJ GEN S.K. SRIVASTAV SHRI MAN SINGH (<i>Alternate</i>)
Ministry of Road Transport & Highways, New Delhi	SHRI A. P. PATHAK SHRI A. K. PANDEY (<i>Alternate</i>)
National Council for Cement and Building Materials, Ballabgarh	SHRI V. V. ARORA DR M. M. ALI (<i>Alternate</i>)
National Test House, Kolkata	SHRI B. R. MEENA SHRIMATI S. A. KAUSHIL (<i>Alternate</i>)
Nuclear Power Corporation of India Ltd, Mumbai	SHRI ARVIND SHRIVASTAVA SHRI RAGHUPATI ROY (<i>Alternate</i>)
OCL India Limited, New Delhi	DR S. C. AHLUWALIA SUPERINTENDING ENGINEER EXECUTIVE ENGINEER (<i>Alternate</i>)
Public Works Department, Govt of Tamil Nadu, Chennai	SHRI BALAJ K. MOORTHY SHRI ANIL KUMAR PILLAI (<i>Alternate</i>)
Ramco Cements Ltd, Chennai	DR D. VENKATESWARAN SHRI S. GOPINATH (<i>Alternate</i>)
The India Cements Limited, Chennai	SHRI P. R. BHAT SHRI S. J. SHAH (<i>Alternate</i>)
The Indian Hume Pipe Company Limited, Mumbai	DR H. C. VISVESVARAYA SHRI S. H. JAIN (<i>Alternate</i>)
The Institution of Engineers (India), Kolkata	DR SUBRATO CHOWDHURY SHRI BISWAJIT DHAR (<i>Alternate</i>)
Ultra Tech Cement Ltd, Mumbai	SHRI M. A. U. KHAN SHRI H. WADHWA (<i>Alternate</i>)
Voluntary Organization in Interest of Consumer Education, New Delhi	SHRI A. K. JAIN
In personal capacity [B-803, Gardenia Building, Malard (East), Mumbai]	SHRI L. K. JAIN
In personal capacity (36, Old Sneh Nagar, Wardha Road, Nagpur)	SHRI R. C. WASON
In personal capacity (EA-92, Maya Enclave, Hari Nagar, New Delhi)	SHRI S. A. REDDI
In personal capacity (E-1, 402, White House Apartments, R.T. Nagar, Bangalore)	SHRI B. K. SINHA, Scientist 'E' and Head (Civ Engg) [Representing Director General (<i>Ex-officio</i>)]
BIS Directorate General	

Member Secretaries

SHRI SANJAY PANT
Scientist 'E' (Civil Engg), BIS

SHRI S. ARUN KUMAR
Scientist 'C' (Civil Engg), BIS
and

SHRIMATI DIVYA S.
Scientist 'B' (Civil Engg), BIS

Panel for Revision of Cement Standards, CED 2/P3

<i>Organization</i>	<i>Representative(s)</i>
In personal capacity, (7A, Autumn Hue, Seasons, PPD *Appartments, Kuravankonam, Trivandrum)	SHRI JOSE KURIAN (<i>Convener</i>)
CSIR-Central Building Research Institute, Roorkee	SHRI S. K. SINGH SHRI SUBHASH GURRAN (<i>Alternate</i>)
Central Public Works Department, New Delhi	SHRI B. B. DHAR SHRI MATHURA PRASAD (<i>Alternate</i>)
CSIR-Central Road Research Institute, Roorkee	DR DEVESH TIWARI SHRI BINOD KUMAR (<i>Alternate</i>)
Central Soil and Materials Research Station, New Delhi	SHRI G. K. VIJH
Indian Concrete Institute, Chennai	SHRI K. P. ABRAHAM
Military Engineer Services, Engineer-in-Chief's Branch, Army HQ, New Delhi	BRIG GIRISH JOSHI LT COL GAURAV KAUSHIK (<i>Alternate</i>)
National Council for Cement and Building Materials, Ballabgath	SHRI V. V. ARORA
Ready Mixed Concrete Manufacturers' Association, Mumbai	SHRI VIJAYKUMAR R. KULKARNI SHRI M. RAVISHANKAR (<i>Alternate</i>)
CSIR-Structural Engineering Research Centre, Chennai	SHRIMATI AMBILY P. S. DR P. SRINIVASAN (<i>Alternate</i>)
In personal capacity (EA-92, Maya Enclave, Hari Nagar, New Delhi)	SHRI R. C. WASON
In personal capacity (Type IV/17, President's Estate, New Delhi)	SHRI K. H. BABU

Bureau of Indian Standards

BIS is a statutory institution established under the *Bureau of Indian Standards Act, 1986* to promote harmonious development of the activities of standardization, marking and quality certification of goods and attending to connected matters in the country.

Copyright

BIS has the copyright of all its publications. No part of these publications may be reproduced in any form without the prior permission in writing of BIS. This does not preclude the free use, in the course of implementing the standard, of necessary details, such as symbols and sizes, type or grade designations. Enquiries relating to copyright be addressed to the Director (Publications), BIS.

Review of Indian Standards

Amendments are issued to standards as the need arises on the basis of comments. Standards are also reviewed periodically; a standard along with amendments is reaffirmed when such review indicates that no changes are needed; if the review indicates that changes are needed, it is taken up for revision. Users of Indian Standards should ascertain that they are in possession of the latest amendments or edition by referring to the latest issue of 'BIS Catalogue' and 'Standards : Monthly Additions'.

This Indian Standard has been developed from Doc No.: CED 02 (7992).

Amendments Issued Since Publication

Amend No.	Date of Issue	Text Affected

BUREAU OF INDIAN STANDARDS

Headquarters:

Manak Bhavan, 9 Bahadur Shah Zafar Marg, New Delhi 110002

Telephones : 2323 0131, 2323 3375, 2323 9402

Website: www.bis.org.in

Regional Offices:

	Telephones
Central : Manak Bhavan, 9 Bahadur Shah Zafar Marg NEW DELHI 110002	{ 2323 7617 2323 3841
Eastern : 1/14 C.I.T. Scheme VII M, V. I. P. Road, Kankurgachi KOLKATA 700054	{ 2337 8499, 2337 8561 2337 8626, 2337 9120
Northern : SCO 335-336, Sector 34-A, CHANDIGARH 160022	{ 260 3843 260 9285
Southern : C.I.T. Campus, IV Cross Road, CHENNAI 600113	{ 2254 1216, 2254 1442 2254 2519, 2254 2315
Western : Manakalaya, E9 MIDC, Marol, Andheri (East) MUMBAI 400093	{ 2832 9295, 2832 7858 2832 7891, 2832 7892

Branches: AHMEDABAD. BENGALURU. BHOPAL. BHUBANESHWAR. COIMBATORE. DEHRADUN. FARIDABAD. GHAZIABAD. GUWAHATI. HYDERABAD. JAIPUR. KOCHI. LUCKNOW. NAGPUR. PARWANOO. PATNA. PUNE. RAJKOT. VISAKHAPATNAM.